

# LEMELSON-MIT

*Celebrating invention, inspiring youth*

## Prototyping Solutions of Inventions

Invention Education  
Webinar Series



Thursday, November 30, 2017

6:30 – 7:00 p.m. ET

# Lemelson-MIT Program Overview

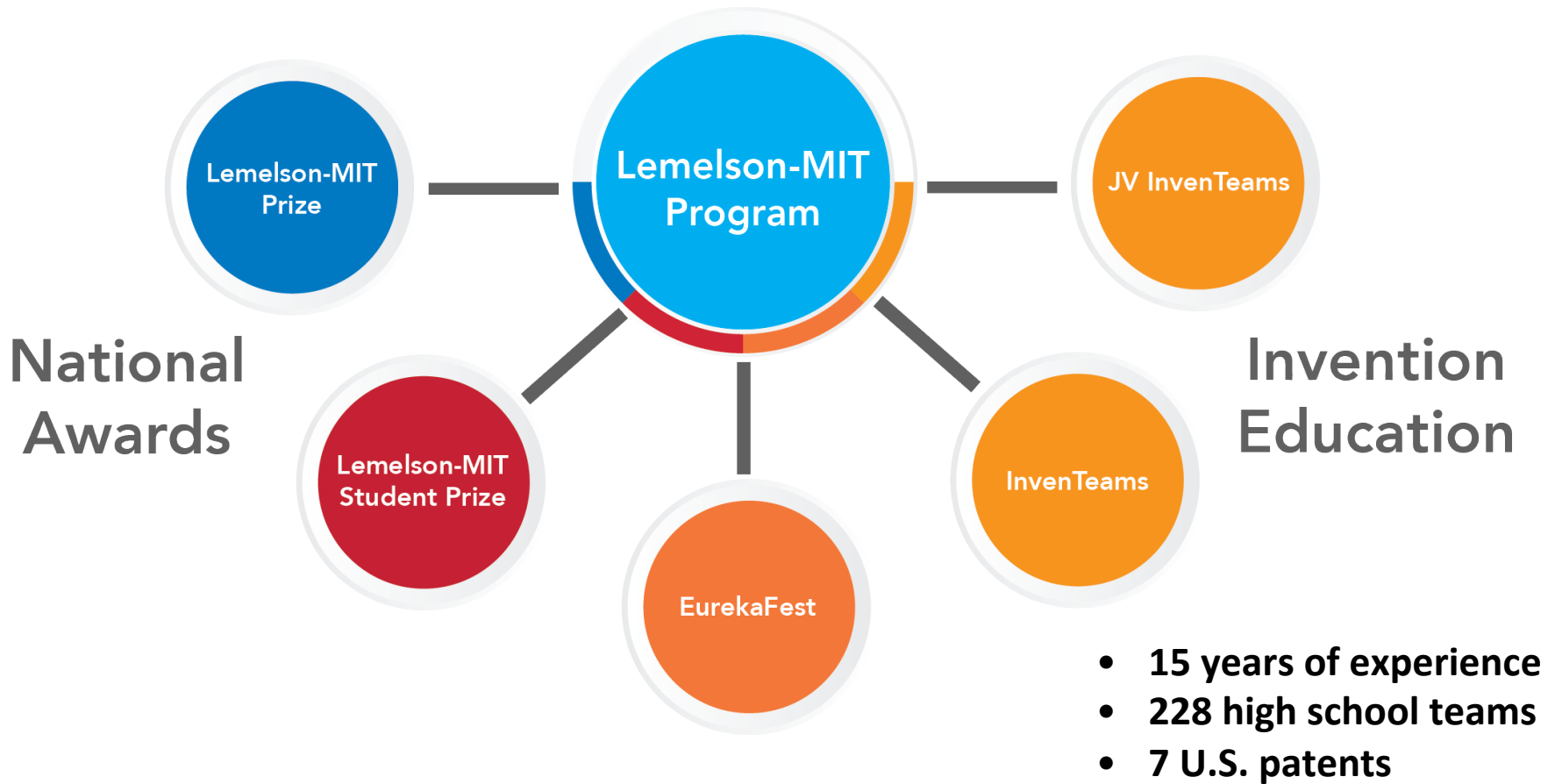

# Presenter Ed Hernandez

- Engineering teacher at Tustin High School, CA
- Director of the T-Tech Academy of Technology and Engineering
- California Career and Technical Education Teacher of the Year (2015)

## Invention Education Experience

Tustin High School InvenTeam (2017)

- Device to remove gum from school sidewalks



# Invention Cycle

## Technical inventions are:

- Useful
- Unique
- Reduced to practice

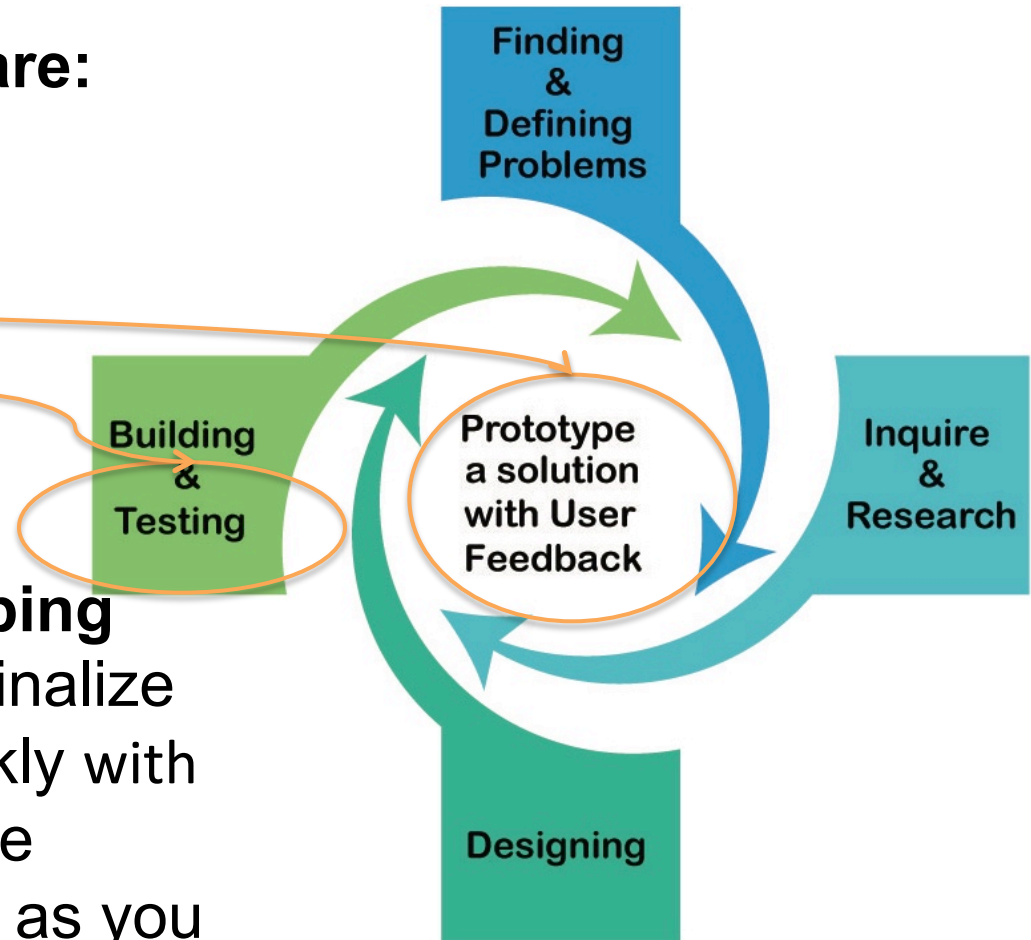

**Modeling and Prototyping Solutions:** Select and finalize invention solutions quickly with user input to help with the selection process; learn as you go

# Low-fidelity, Alpha, or Basic Prototypes

Models and prototypes can be made from readily available materials or kits to create multiple solutions that can generate a response from a user

- Easy
- Cheap
- Quick

What materials do you have on-hand for prototyping?



Leatherman® multi-tool prototypes created using wood (left) and cardboard (right).

# Prototyping Solutions

Prototypes can be mock-ups for early conceptualizations or parts of the final solution.

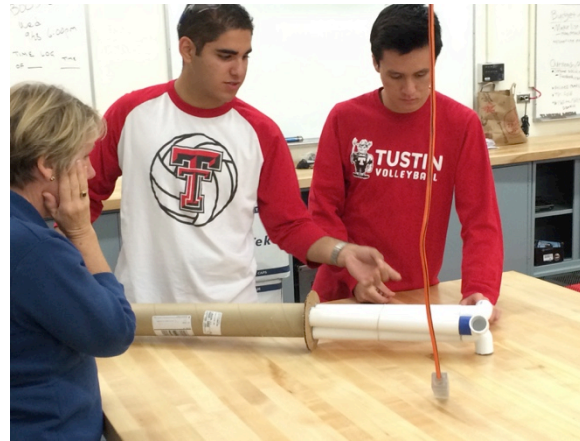
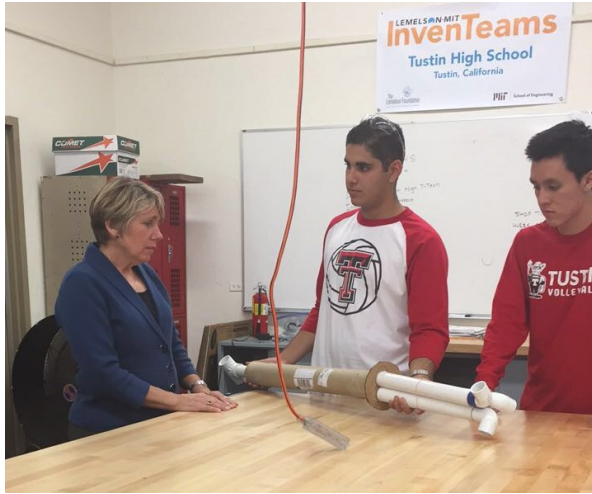

Original prototype of Tustin High School InventTeam's Gum Remover was made of cardboard and PVC pipes.

# High-fidelity, Beta, or Complex Prototypes

Prototypes eventually develop into an operational version of a solution. Manufacturing and commercialization is an ultimate goal of many inventions.

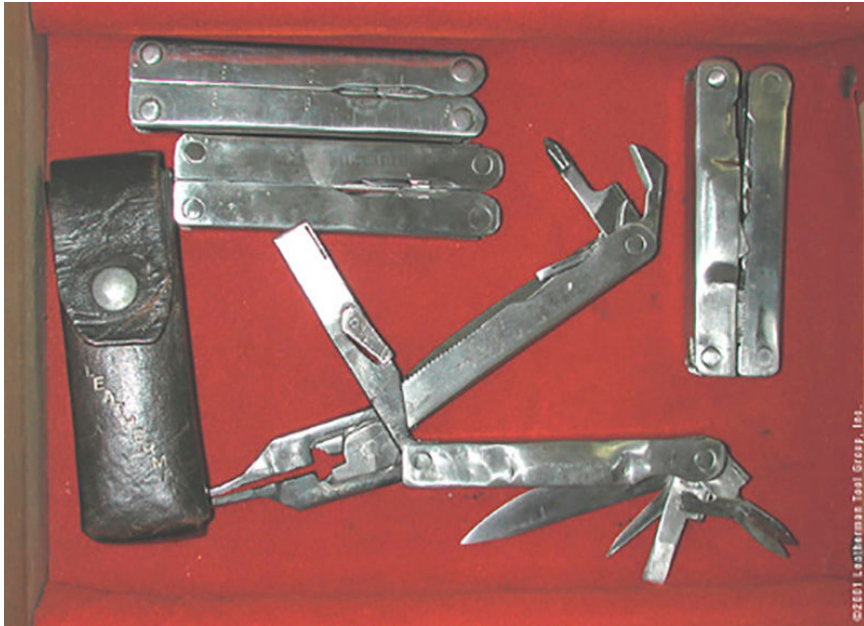

A near-final prototype featured a clamp and scissors



Commercial Leatherman multi-tool

# 3-D Printing for Prototyping Solutions

3-D printing can be a great tool for prototyping solutions.

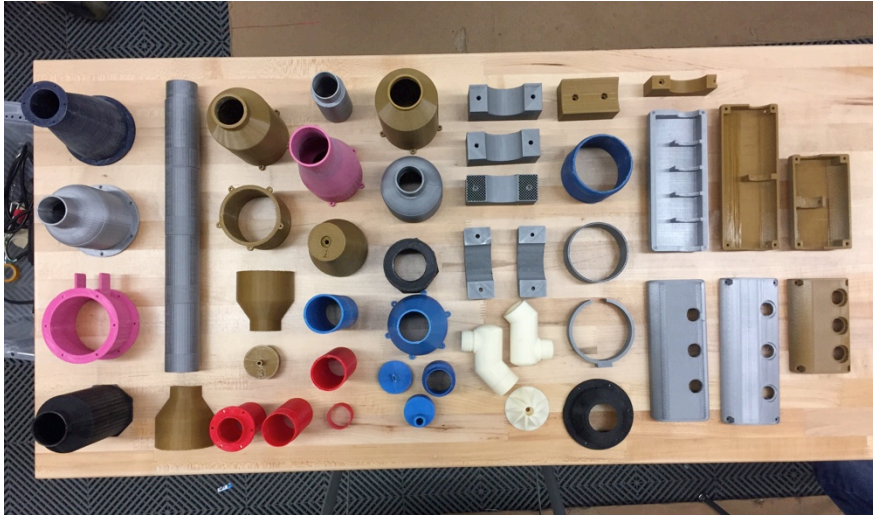

Half of the total amount of 3-D printed parts “printed” for the Gum Remover

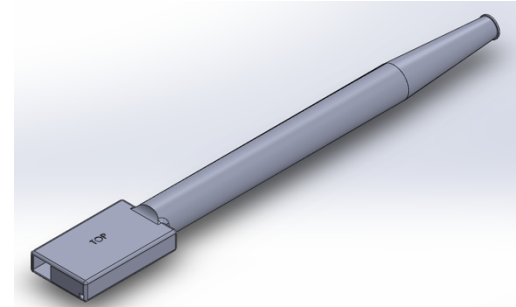

First 3D model drawn in [SolidWorks](#).

Other CAD software:

[Fusion360](#)

[AutoCAD](#)

[Autodesk Inventor](#)

[Onshape](#)

[Sketchup](#)



# Tustin High School InvenTeam Prototypes

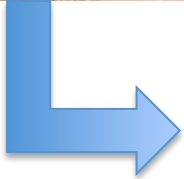
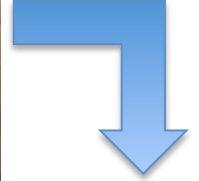
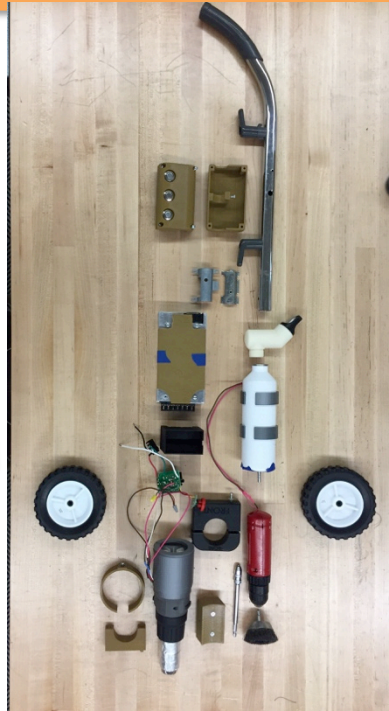

*Progression of Tustin High School's InvenTeam project prototypes*

# Each picture tells a story



Find what is already available



Our mid-grant review demo was basic at best



Get dirty!



Do the math & science!

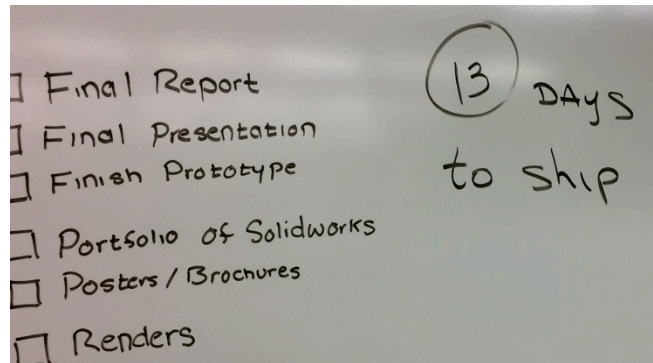

Keep track of deadlines



Inventing is messy!

# Prototyping Guidelines

---

- Just start!
  - ✓ Have materials on-hand (clay, cardboard, foam, duct tape)
- Don't spend too much time on one prototype
  - ✓ Make multiple prototypes
- Remember *why* you're prototyping
- Keep the needs of the user/client/beneficiary in mind
- Learn by doing

# Lemelson-MIT Resources

---

- Lemelson-MIT Program  
<http://lemelson.mit.edu/>
- InvenTeams National Grants Initiative  
<http://lemelson.mit.edu/inventeams>
- JV InvenTeams Curriculum Materials  
<http://lemelson.mit.edu/jv-inventeams>
- Inventor Archive  
<http://lemelson.mit.edu/search-inventors>

# Other Resources

---

## [Leatherman History](#)

This is a report on how the Leatherman multi-tool was invented, prototyped, and finalized.

## [How Nike designs for NBA Athletes](#)

A great video showing how design occurs (from idea, to research, prototyping, and user for feedback) when Nike designed apparel for NBA athletes.

## [Prototyping through Reynolds Materials](#)

## [ProtoLabs](#)

A company specializes in providing prototypes using 3D printing, CNC machining, and injection molding. Professional engineers will provide feedback on whether a design can be printed.

# Q & A

*What brand/model of 3D printer do you use or would recommend?*

We recommend having two machines if possible because you can print prototypes faster with two. If one printer breaks down, you'll still have the other one.

**For the price around \$1,500**, we would recommend Robo3D as it is stable and has great tech support.

<http://www.matterhackers.com/store//robo3d-r2-high-performance-smart-3d-printer/sk/MKK5CNCE>

We also recommend using 1.75mm PLA filament as it is the easiest filament to use.

<http://www.matterhackers.com/store/c/PRO%20series%20PLA>

**For the price lower, around \$200**, we would recommend Mini 3D printers (see the picture on the right)

[https://www.monoprice.com/product?p\\_id=15365](https://www.monoprice.com/product?p_id=15365)

For larger prints, you can use this one:

[https://www.monoprice.com/product?p\\_id=15711](https://www.monoprice.com/product?p_id=15711)

The PLA filament can be found at

<http://gizmodorks.com/pla-3d-printer-filament/>

**Please note the PLA filament will degrade, it'll be best to store them in sealed buckets!!**

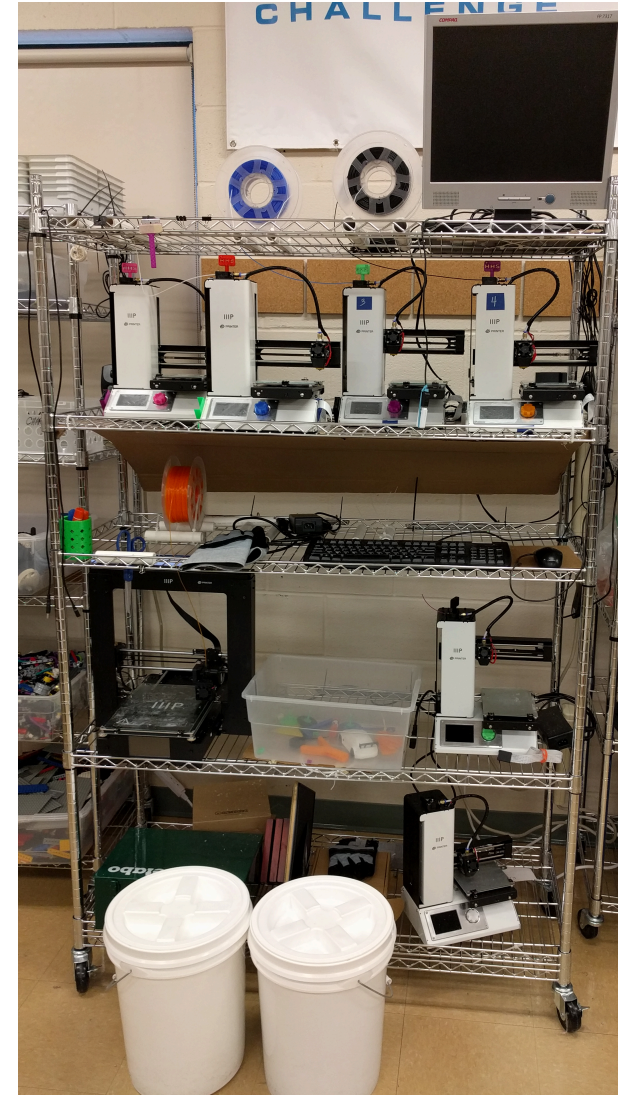

# Q & A

*Can invention projects occur in after school settings only or was part of a specific or elective class?*

Invention projects can take place in formal and informal settings. Our co-host Ed implemented invention projects in his engineering capstone class where students worked in two teams on inventions during class. Students also came to the maker space in afterschool time and on Saturdays to continue working on the projects. The most important thing is to get students excited on the project. Once they are excited, they will find their way to spend more time working on it!

*How many students involved, how often did you meet, was it always at school or did you utilize other community resources?*

InvenTeams, supported by our InvenTeams grants initiative, typically involve 10 to 20 high school students working on an invention project identified by the students during out-of-school time. Students spend approximately 8 months creating a working prototype of the invention. They meet in afterschool time and on weekends. Again, once students become excited about the project, they will find time to work on it!

The InvenTeams utilize lots of support from the local community such as town officials, firefighters, policemen, local manufacturing facilities, engineers, etc. They can also utilize resources from the school and parents. For instance, Ed's team was supported by the chemistry teachers for testing different materials in the labs. Parents who are professional engineers are a great resource as well.

# LEMELSON-MIT

*Celebrating invention, inspiring youth*

**THANK YOU!**

Contact Us at  
[PD-lemelson@mit.edu](mailto:PD-lemelson@mit.edu)

Invention Education  
Webinar Series

